



# African Junior Championships Individuals 2022

Kenya, Nairobi, 23 Jul 2022

## -60 kg

Juniors (17)

POOL A

	MBALLO Oumar	SEN
	KAMARA Mohamed	SLE
	RABACAL Leonardo	ANG
	SCHULTZ Dewald	RSA
	PHUTHEGO Tumiso	BOT

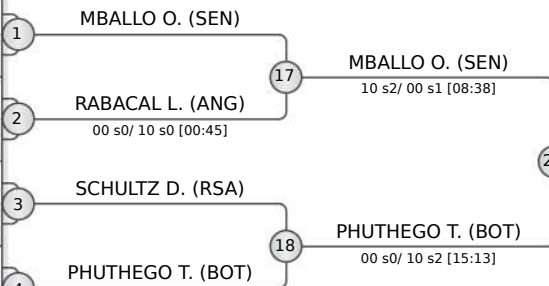

POOL B

	COULIBALY Kassoum Gbon Aboubacar	CIV
	BIRUKUNDI Evodius	BDI
	MWABA Jonathan	ZAM
	WAMBUA James	KEN

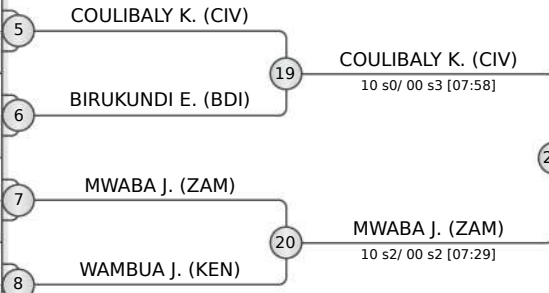

POOL C

	IDRISSA SALEY Ridouane	NIG
	BARROS Leonardo	ANG
	SAMY Youssry	EGY
	NJERU Stephen Mwangi	KEN

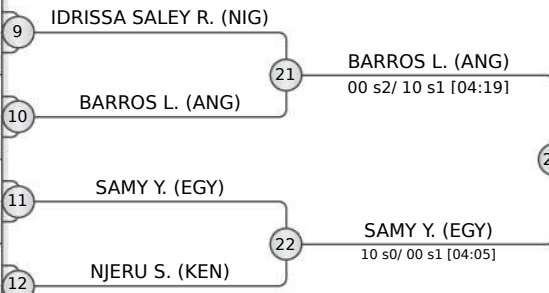

POOL D

	KOUASSI Kouakou Jean Marc	CIV
	EVOUNA BELOBO Didier Barthelemy	CMR
	NGANJI Raoul Brilliant	BDI
	KALUSA John	ZAM

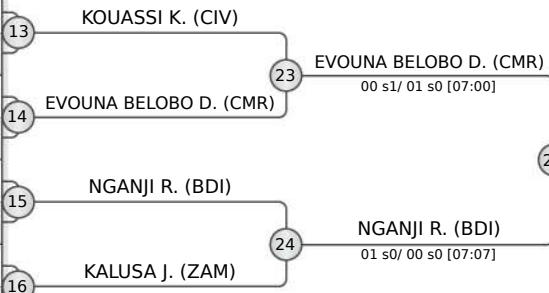

REPECHAGE

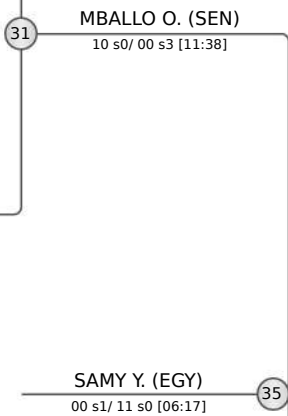
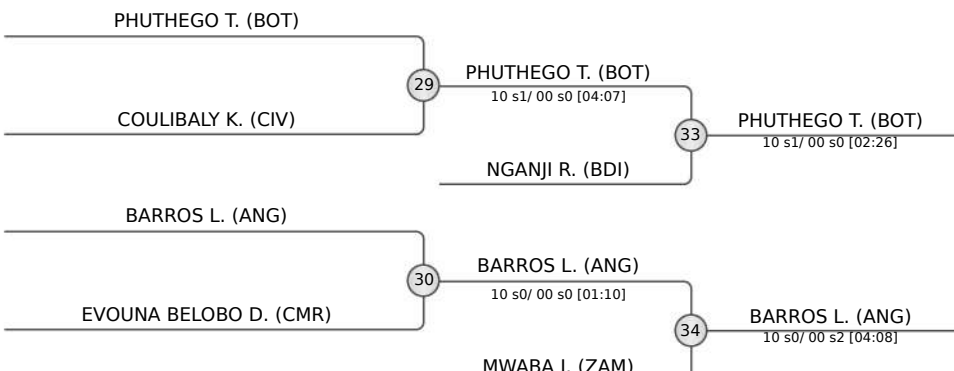

FINAL RESULTS	
1. SAMY Youssry	
2. MBALLO Oumar	
3. PHUTHEGO Tumiso	
3. BARROS Leonardo	
5. NGANJI Raoul Brilliant	
5. MWABA Jonathan	
7. COULIBALY Kassoum Gbon Aboubacar	
7. EVOUNA BELOBO Didier Barthelemy	



# African Junior Championships Individuals 2022

Kenya, Nairobi, 23 Jul 2022

## -66 kg

Juniors (21)

POOL A

	TAIBI Mohamed	MAR
	WALI Regan Mwandu	KEN
	TCHOUACHOU NKEPYA Franck Olivier Stone	CMR
	NIYOMWUNGERE Beive	BDI
	NASSER Djamal-Eddine Ali	COM

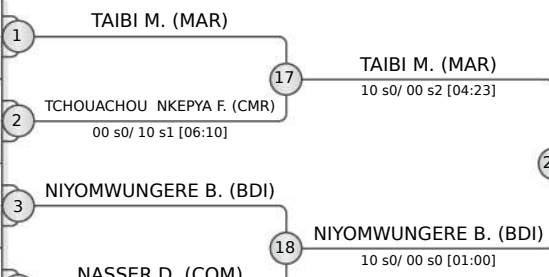

POOL B

	DIALLO Akim	BUR
	HAMADA Adel	EGY
	QUIDEVILLE SINO Pierre Henri	GAB
	N GUESSAN Kouassi Yann Privat	CIV
	RIBEIRO JUNIOR Paulo	MOZ
	DALA Augusto	ANG

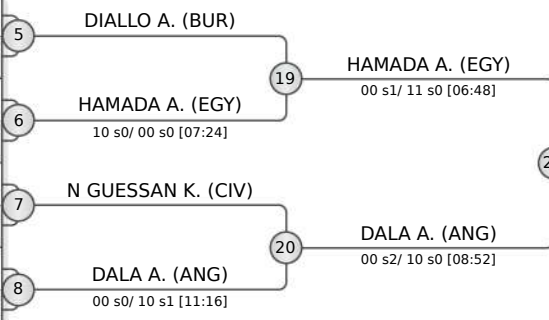

POOL C

	NKERO Fernand	GAB
	OKOKO Felix	KEN
	MOGASE WILLIAMS Neo	RSA
	ELMESSAOUDI Ayoub	MAR
	MANJATE Marcelino	MOZ

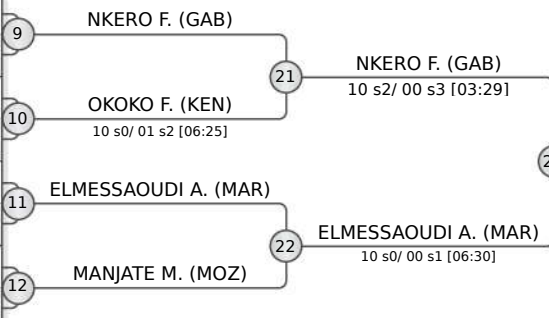

POOL D

	MBOUP Mouhamedou	SEN
	PAZIAUD Koga	GAM
	CESAR Renato	ANG
	DIAWARA Harouna	GUI
	IRAKOZE Lin	BDI

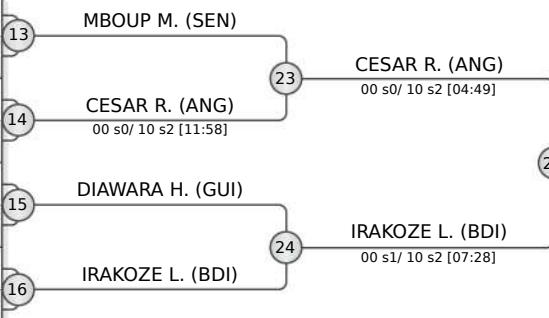

REPECHAGE

NIYOMWUNGERE B. (BDI)	29 DALA A. (ANG) [02:33]
DALA A. (ANG)	33 DALA A. (ANG) [10 s0/ 00 s1 [04:51]]
ELMESSAOUDI A. (MAR)	30 CESAR R. (ANG) [06:25]
CESAR R. (ANG)	34 TAIBI M. (MAR) [09:50]
TAIBI M. (MAR)	

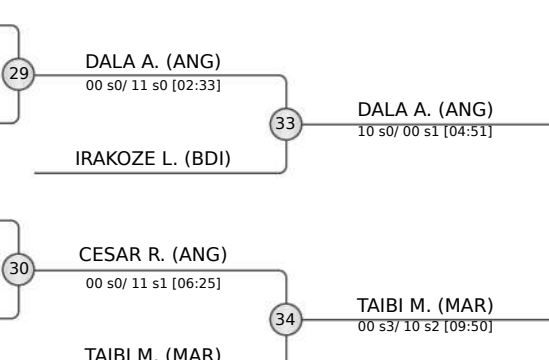

### FINAL RESULTS

1. NKERO Fernand	GAB
2. HAMADA Adel	EGY
3. DALA Augusto	ANG
3. TAIBI Mohamed	MAR
5. IRAKOZE Lin	BDI
5. CESAR Renato	ANG
7. NIYOMWUNGERE Beive	BDI
7. ELMESSAOUDI Ayoub	MAR

**POOL A**

	DOUKKALI Hassan	MAR
	KAPUNGWE John	ZAM
	GABRIEL Zeferino	ANG

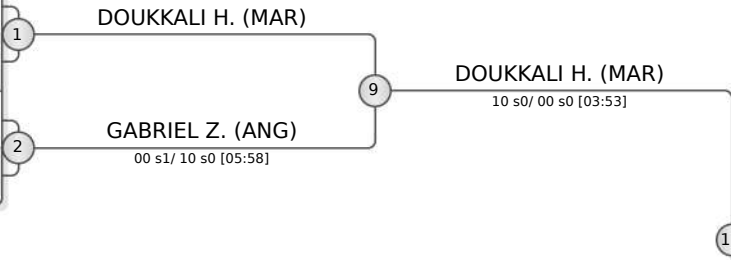

**POOL B**

	MOLEFE Moagi	RSA
	ELTANAHY Marawan	EGY
	JERAINI James	KEN
	KOM TEDDY Enzy	CMR

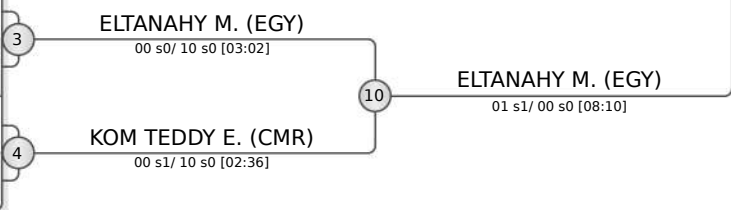

**POOL C**

	DIALLO Alhassane	GUI
	MEUWSEN Timothy	RSA
	DOMINGOS Leonardo	ANG

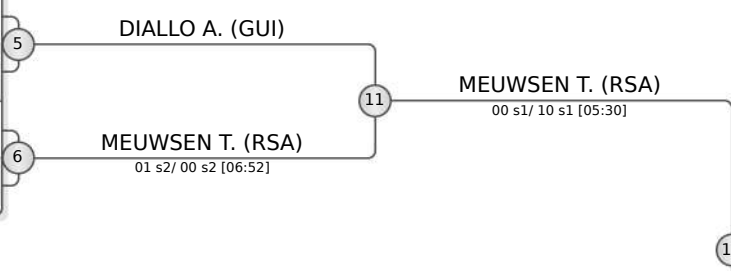

**POOL D**

	MILLIMOUNO Balla Victor	GUI
	LAHMOURI Nouh	MAR
	NKOTT PONDY KONA Mike Pawl Allan	CMR
	RANDRIANASOLO Lova Mahaisoa	MAD

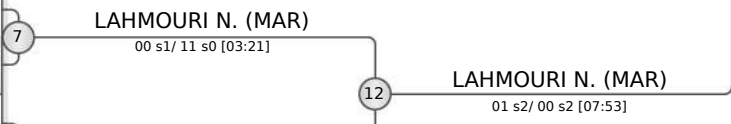

**REPECHAGE**

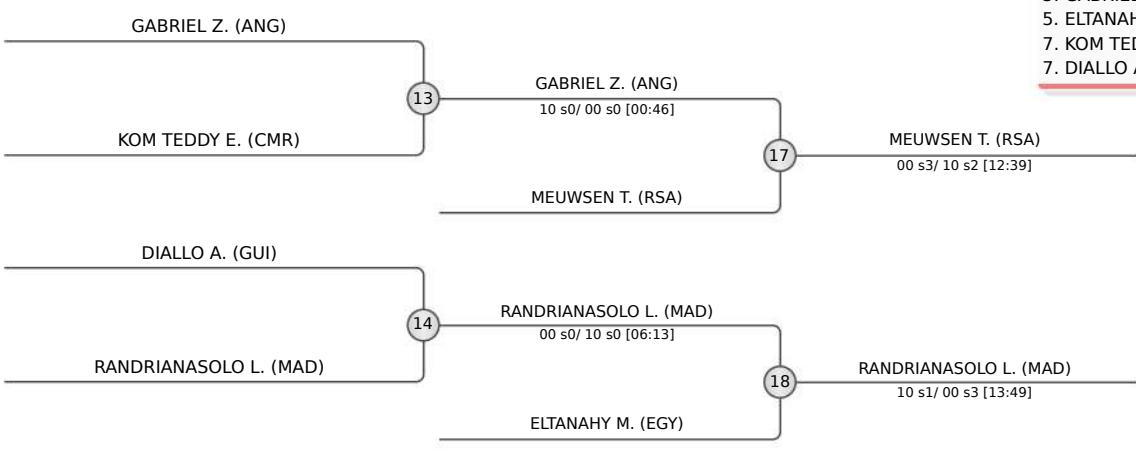

FINAL RESULTS		
1.	DOUKKALI Hassan	MAR
2.	LAHMOURI Nouh	MAR
3.	MEUWSEN Timothy	RSA
3.	RANDRIANASOLO Lova Mahaisoa	MA
5.	GABRIEL Zeferino	ANG
5.	ELTANAHY Marawan	EGY
7.	KOM TEDDY Enzy	CMR
7.	DIALLO Alhassane	GUI

**POOL A**

	KEITA Djibrel	GUI
	DE NEYS Henk	RSA
	ABDELAAL Aly	EGY

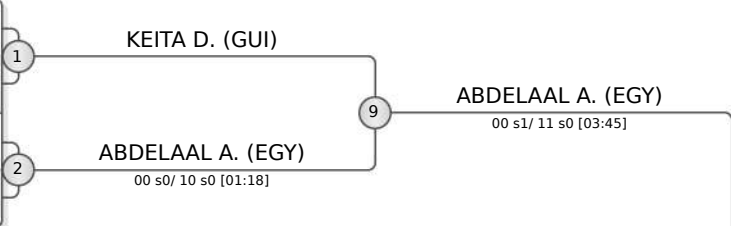

**POOL B**

	SILVA Deny	ANG
	BOUGUENG KOMBOU Rayan	CMR
	WAMBUA Christopher	KEN

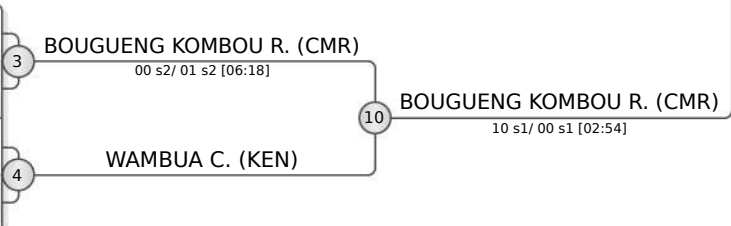

**POOL C**

	DIALLO Alhaamdou	GUI
	HAKIZIMANA Sammy	BDI
	BEINA BANGMO Robert Laurent Raziel	CMR

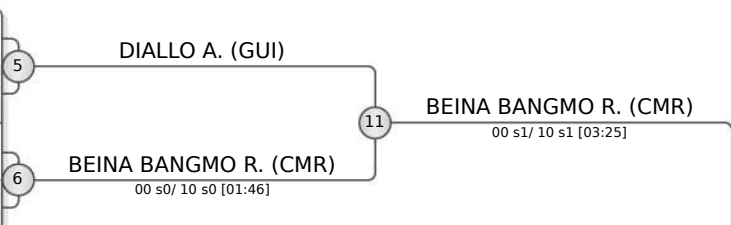

**POOL D**

	DE OLIVEIRA Marciano	RSA
	ELDALY Ziad	EGY

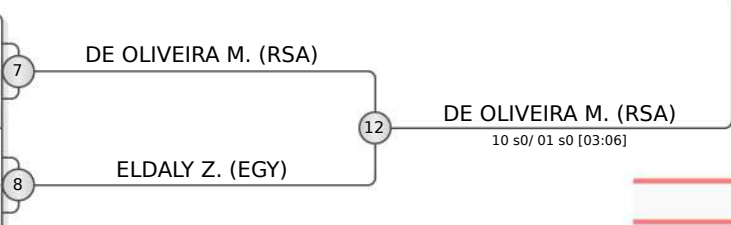

**REPECHAGE**

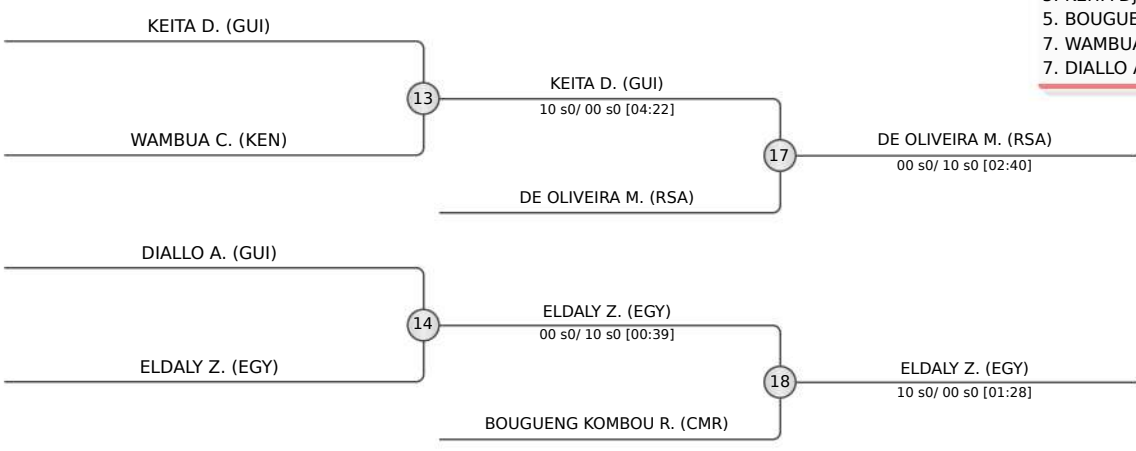

FINAL RESULTS		
1.	ABDELAAL Aly	EGY
2.	BEINA BANGMO Robert Laurent Raziel	CMR
3.	DE OLIVEIRA Marciano	RSA
3.	ELDALY Ziad	EGY
5.	KEITA Djibrel	GUI
5.	BOUGUENG KOMBOU Rayan	CMR
7.	WAMBUA Christopher	KEN
7.	DIALLO Alhaamdou	GUI

Num.	Competitor	State	1	3	5	Wins	Points
1.	MBUGUA Denis Mwangi	Kenya		0	0	0	0
3.	TCHISSENDE Adriano	Angola	0		0	1	0
5.	ELRAMLY Omar	Egypt	0	0		0	0

Num.	Competitor	State	2	4	Wins	Points
2.	DACOSTA Ryan	Senegal		0	1	0
4.	NGUEYA NAHEU Vladimir Carlos	Cameroon	0		1	0

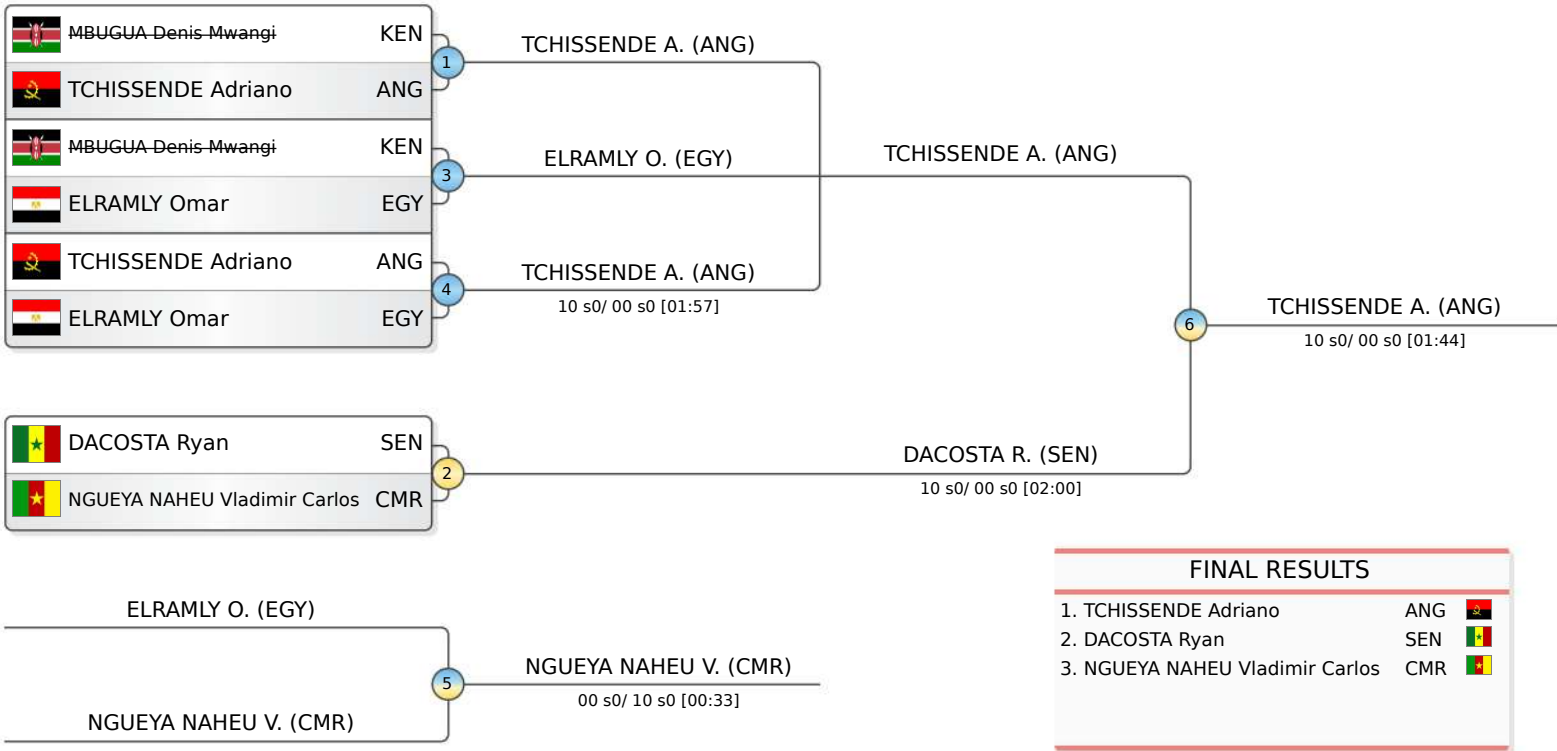

FINAL RESULTS		
1.	TCHISSENDE Adriano	ANG
2.	DACOSTA Ryan	SEN
3.	NGUEYA NAHEU Vladimir Carlos	CMR

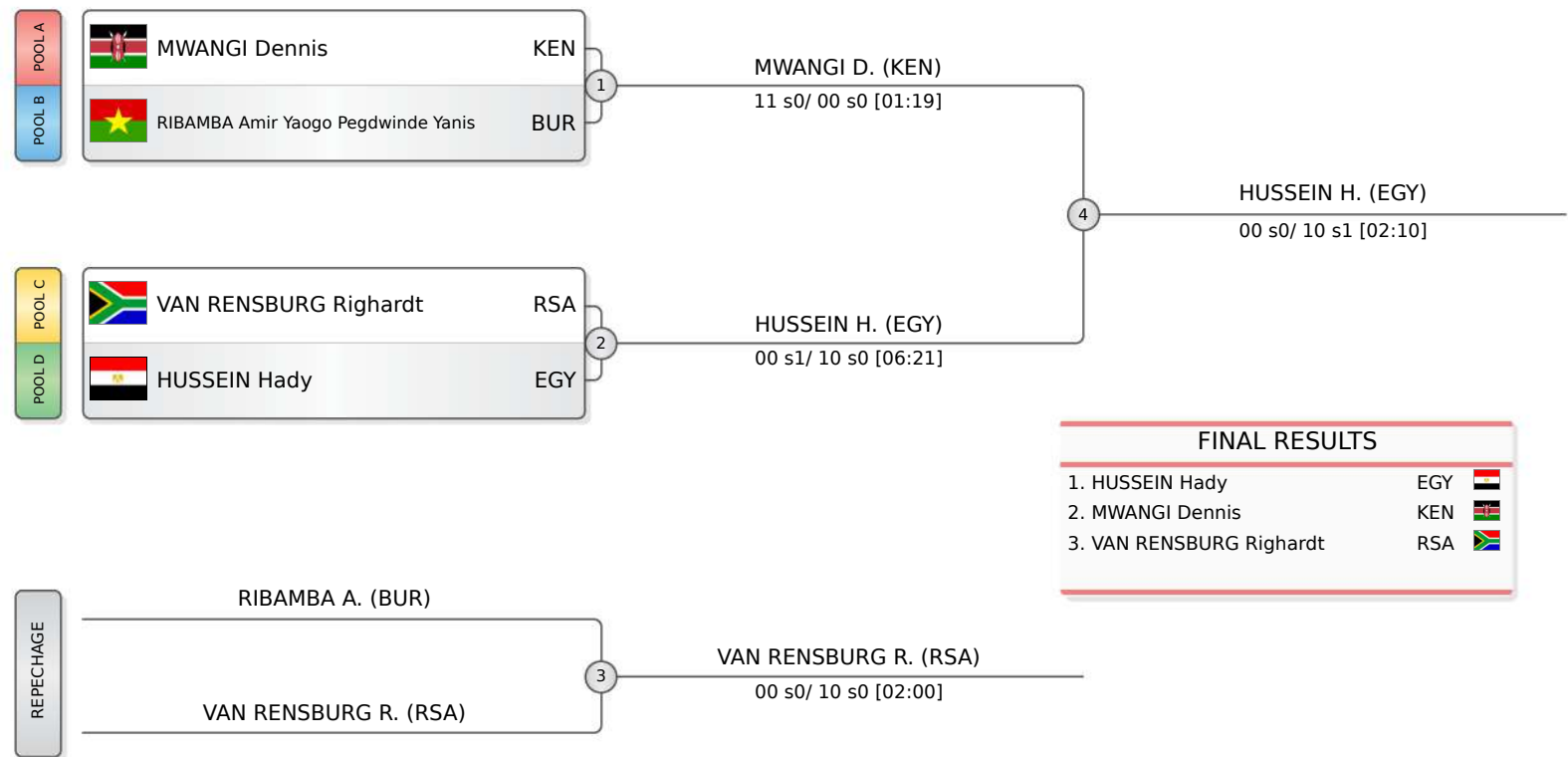

FINAL RESULTS		
1.	HUSSEIN Hady	EGY 
2.	MWANGI Dennis	KEN 
3.	VAN RENSBURG Righardt	RSA 

**POOL A**

 NDIAYE Libasse SEN

1 NDIAYE L. (SEN)

**POOL B**

 ABDELSAMIEA Ahmed EGY

 NTACOBAZONGIRA Mahmoud BDI

2 ABDELSAMIEA A. (EGY)  
10 s0/ 00 s0 [02:25]

**POOL C**

 NIZIGIYIMANA Eloge BDI

3 NIZIGIYIMANA E. (BDI)

**POOL D**

 MATOMBI Malfrat ZIM

 JOAO Elton ANG

4 JOAO E. (ANG)  
00 s1/ 10 s0 [03:52]

7 ABDELSAMIEA A. (EGY)  
00 s1/ 10 s2 [06:08]

8 JOAO E. (ANG)  
00 s1/ 10 s1 [03:26]

11 ABDELSAMIEA A. (EGY)  
01 s2/ 00 s2 [07:06]

**FINAL RESULTS**

- |                           |     |                                                                                       |
|---------------------------|-----|---------------------------------------------------------------------------------------|
| 1. ABDELSAMIEA Ahmed      | EGY |  |
| 2. JOAO Elton             | ANG |  |
| 3. NTACOBAZONGIRA Mahmoud | BDI |  |
| 3. NDIAYE Libasse         | SEN |  |
| 5. NIZIGIYIMANA Eloge     | BDI |  |
| 5. MATOMBI Malfrat        | ZIM |  |

**REPECHAGE**

5 NTACOBAZONGIRA M. (BDI)

NTACOBAZONGIRA M. (BDI)

9 NTACOBAZONGIRA M. (BDI)  
10 s2/ 00 s2 [04:21]

6 MATOMBI M. (ZIM)

MATOMBI M. (ZIM)

10 NDIAYE L. (SEN)  
10 s2/ 00 s2 [04:21]

NDIAYE L. (SEN)



# African Junior Championships Individuals 2022

Kenya, Nairobi, 23 Jul 2022

## -48 kg

Juniors (12)

POOL A

	SONKO Diakhou Sene	SEN
	SALEM Noura	EGY
	GABRIEL Vania	ANG

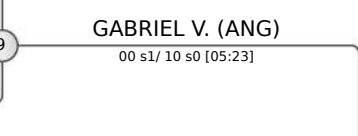
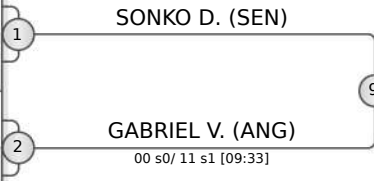

POOL B

	BILLSON Billieleigh	RSA
	KAMPALA Jeanne	BDI
	NSAME MBONGO Fiona	CMR

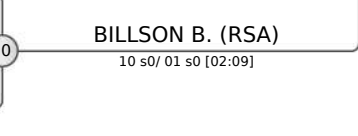
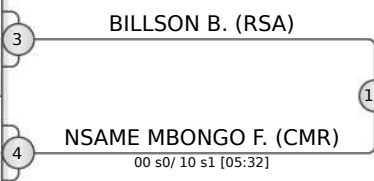

POOL C

	MUNEME Jennie	MOZ
	CINDY GRACE Mpemes	CMR
	SEGUNDA Eldimira	ANG

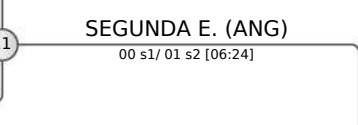
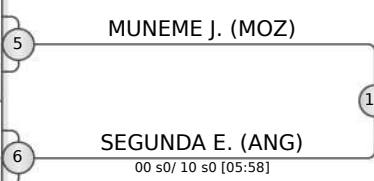

POOL D

	MOHAMED Nisbaty	COM
	MWIKALI Mary	KEN
	UWIMANA Natacha	BDI

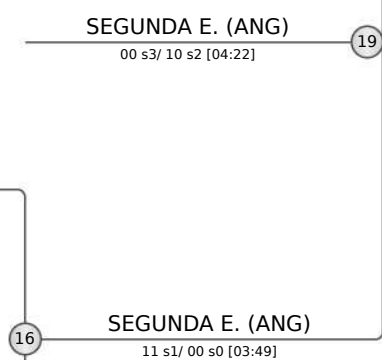
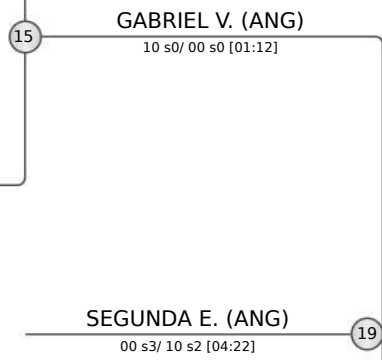
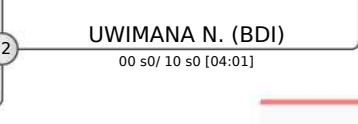
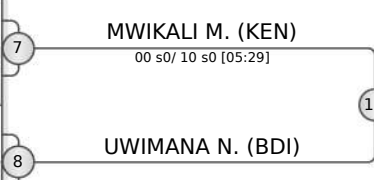

REPECHAGE

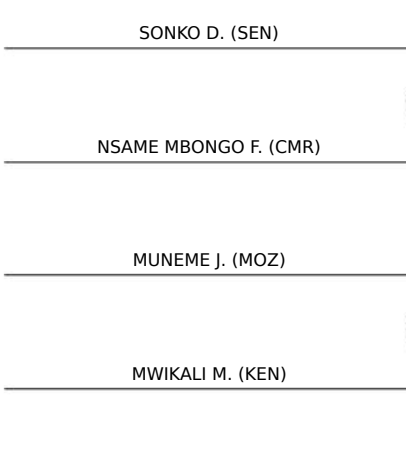

FINAL RESULTS		
1.	SEGUNDA Eldimira	ANG
2.	GABRIEL Vania	ANG
3.	NSAME MBONGO Fiona	CMR
3.	MUNEME Jennie	MOZ
5.	UWIMANA Natacha	BDI
5.	BILLSON Billieleigh	RSA
7.	SONKO Diakhou Sene	SEN
7.	MWIKALI Mary	KEN



**POOL A**

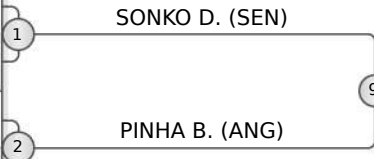

	SONKO Diodio	SEN
	PINHA Beumara	ANG



SONKO D. (SEN)

10 s1/ 00 s3 [09:38]

**POOL B**

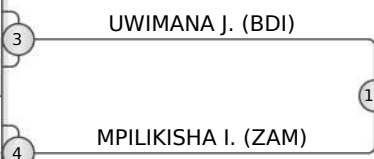

	UWIMANA Julienne	BDI
	MPILIKISHA Ireen	ZAM
	FENOUE SEUGUE Paola Yvonne	CMR



MPILIKISHA I. (ZAM)

00 s1/ 10 s1 [06:44]

**POOL C**

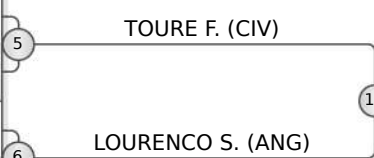

	TOURE Fatim	CIV
	LOURENCO Sonia	ANG
	BADRU Cinthya	MOZ



LOURENCO S. (ANG)

00 s0/ 10 s1 [03:27]

**POOL D**

	ALI Nada Fayiz	EGY
	MOYO Hawaa Abdala	KEN

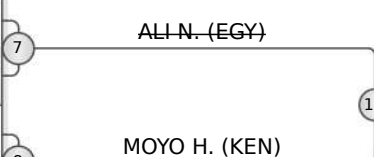

MOYO H. (KEN)

**REPECHAGE**

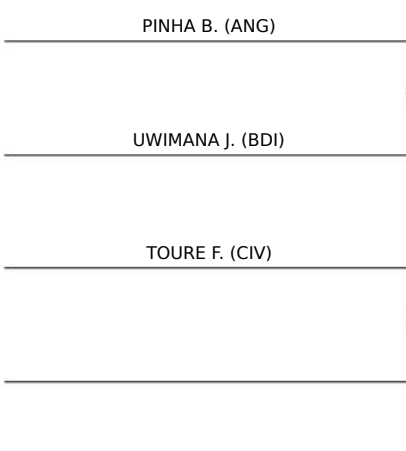

UWIMANA J. (BDI)

00 s0/ 10 s0 [01:27]

17

MOYO H. (KEN)

UWIMANA J. (BDI)

10 s0/ 00 s0 [01:05]

TOURE F. (CIV)

18

MPILIKISHA I. (ZAM)

TOURE F. (CIV)

10 s0/ 00 s1 [02:57]

LOURENCO S. (ANG)

00 s1/ 01 s2 [12:14]

19

SONKO D. (SEN)

10 s0/ 00 s0 [08:03]

15

LOURENCO S. (ANG)

10 s0/ 00 s0 [00:44]

16

FINAL RESULTS		
1. LOURENCO Sonia	ANG	
2. SONKO Diodio	SEN	
3. UWIMANA Julienne	BDI	
3. TOURE Fatim	CIV	
5. MOYO Hawaa Abdala	KEN	
5. MPILIKISHA Ireen	ZAM	
7. PINHA Beumara	ANG	



# African Junior Championships Individuals 2022

Kenya, Nairobi, 23 Jul 2022

**-57 kg**  
Juniors (14)

**POOL A**

	BANGOURA M Mah	GUI
	IRAKIZA Ines	BDI
	FENOUE-NOUBISSI Manuella-Agnes-Lucie	CMR

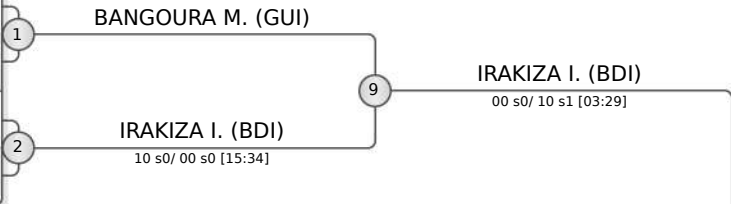

**POOL B**

	ALTAEB Haneen	EGY
	FREIRE Jeovana	ANG
	ZIANE Wissal	MAR
	KANDELA Anita	ZAM

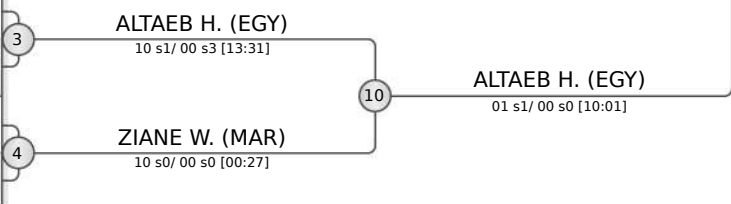

**POOL C**

	EHOUE Mahiva Audrey Anais	CIV
	WAHL Kristen	RSA
	SIMBI Seabel	ZIM

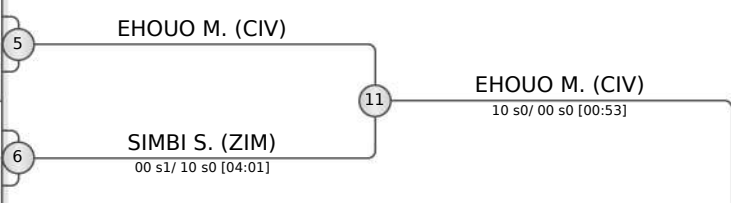

**POOL D**

	MUGURE Teresiah Wairimu	KEN
	MPAWENIMANA Ghyslaine	BDI
	TSEMANE Shenidy	MOZ
	ROSHDY Tassnim	EGY

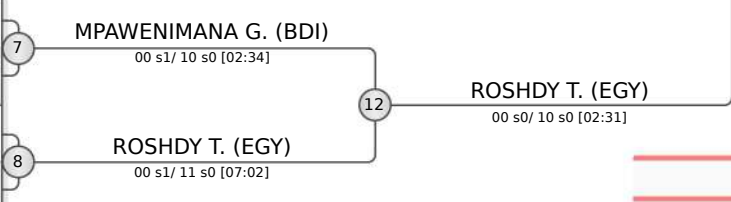

**REPECHAGE**

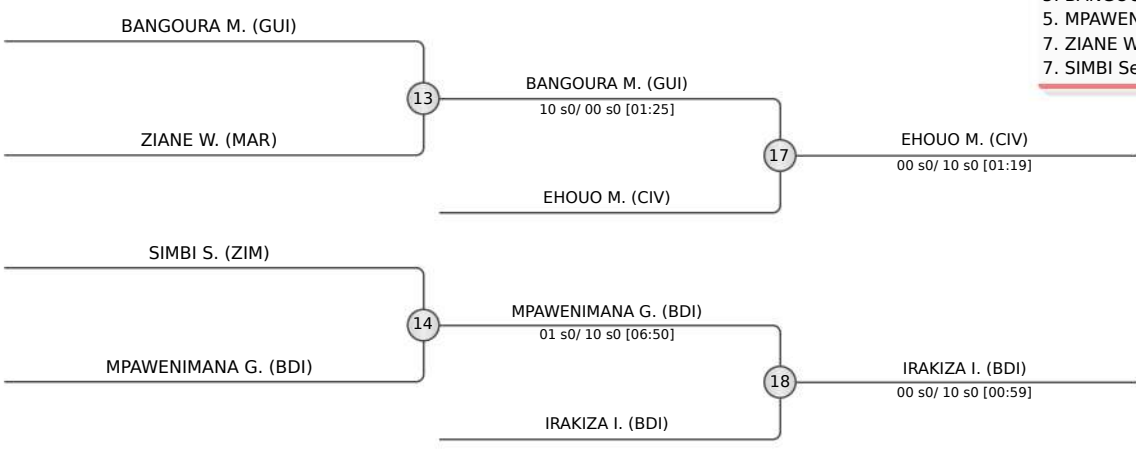

FINAL RESULTS		
1.	ALTAEB Haneen	EGY
2.	ROSHDY Tassnim	EGY
3.	EHOUE Mahiva Audrey Anais	CIV
3.	IRAKIZA Ines	BDI
5.	BANGOURA M Mah	GUI
5.	MPAWENIMANA Ghyslaine	BDI
7.	ZIANE Wissal	MAR
7.	SIMBI Seabel	ZIM



# African Junior Championships Individuals 2022

Kenya, Nairobi, 23 Jul 2022

## -63 kg

Juniors (10)

POOL A

	SAMBOU Adama	SEN
	JAIME Maria Domingas	ANG
	KUPATA Dorcas	KEN

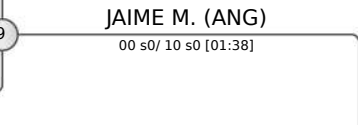
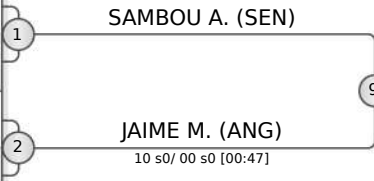

POOL B

	MALHERBE Tegan	RSA
	MEFO MEULI TCHOUONZE Manuela	CMR

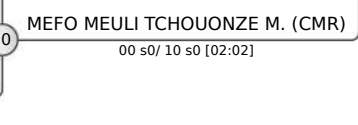
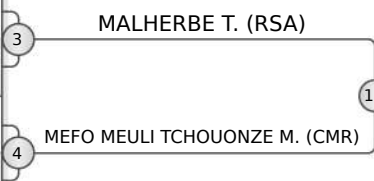

POOL C

	COMPAORE A. Yasmine	BUR
	GHANEM Fatma	EGY

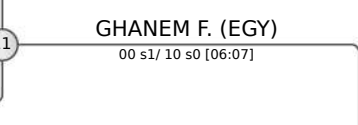
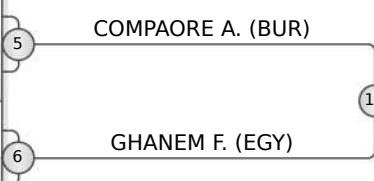

POOL D

	CISSE Aicha	CIV
	COETZEE Nichelle	RSA
	NONE Grace	KEN

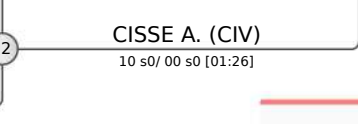
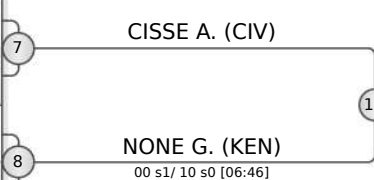

REPECHAGE

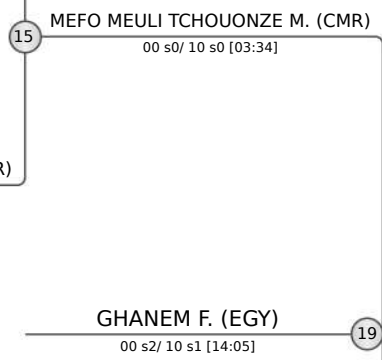
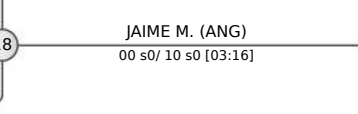
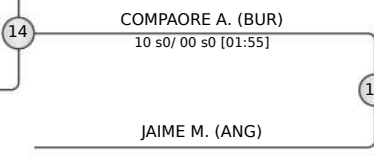
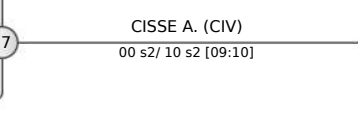
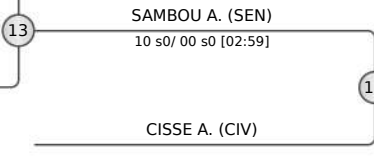

SAMBOU A. (SEN)
MALHERBE T. (RSA)
COMPAORE A. (BUR)
NONE G. (KEN)

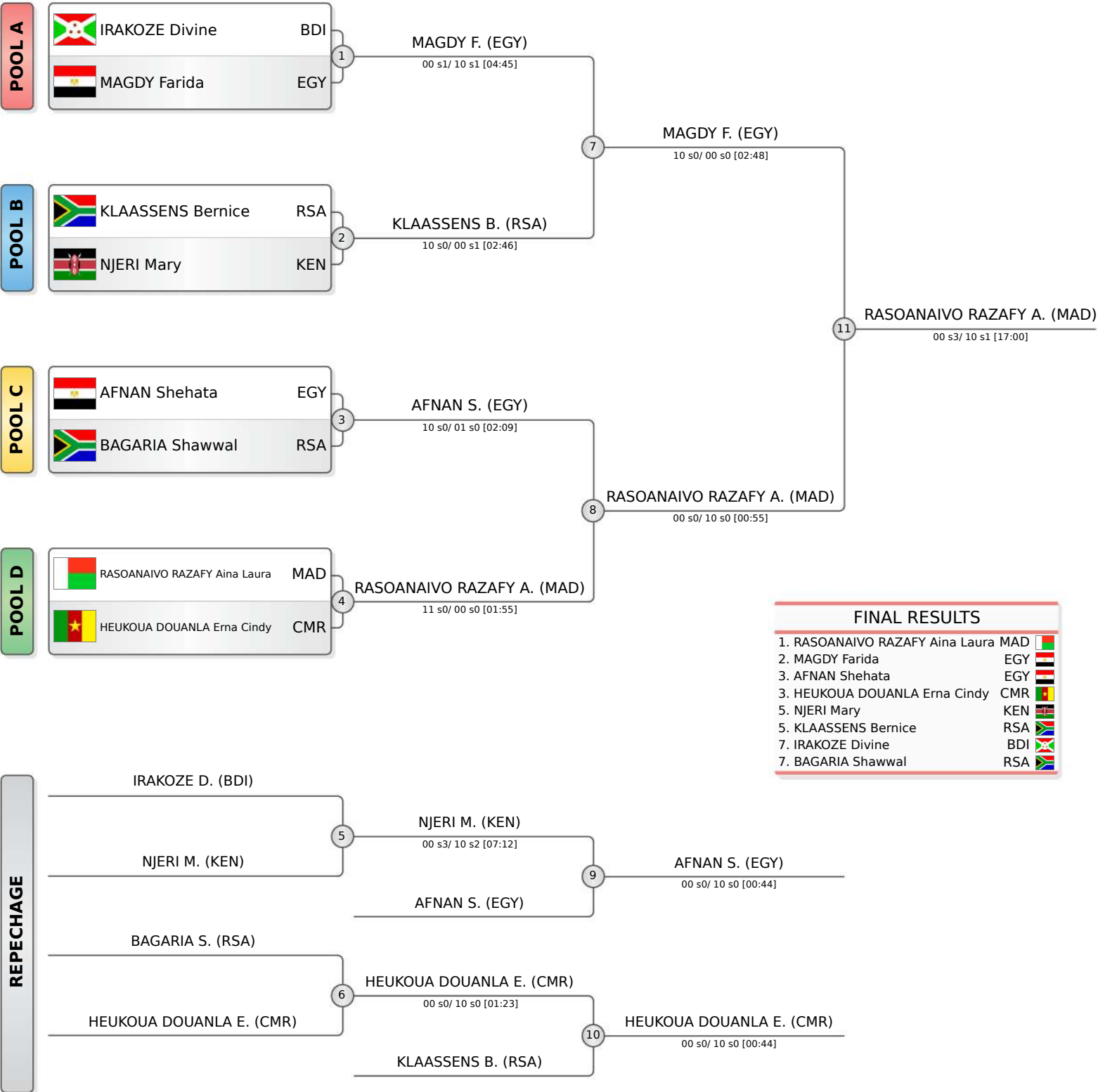

FINAL RESULTS		
1.	GHANEM Fatma	EGY
2.	MEFO MEULI TCHOUONZE Manuela	CMR
3.	CISSE Aicha	CIV
3.	JAIME Maria Domingas	ANG
5.	SAMBOU Adama	SEN
5.	COMPAORE A. Yasmine	BUR
7.	MALHERBE Tegan	RSA
7.	NONE Grace	KEN

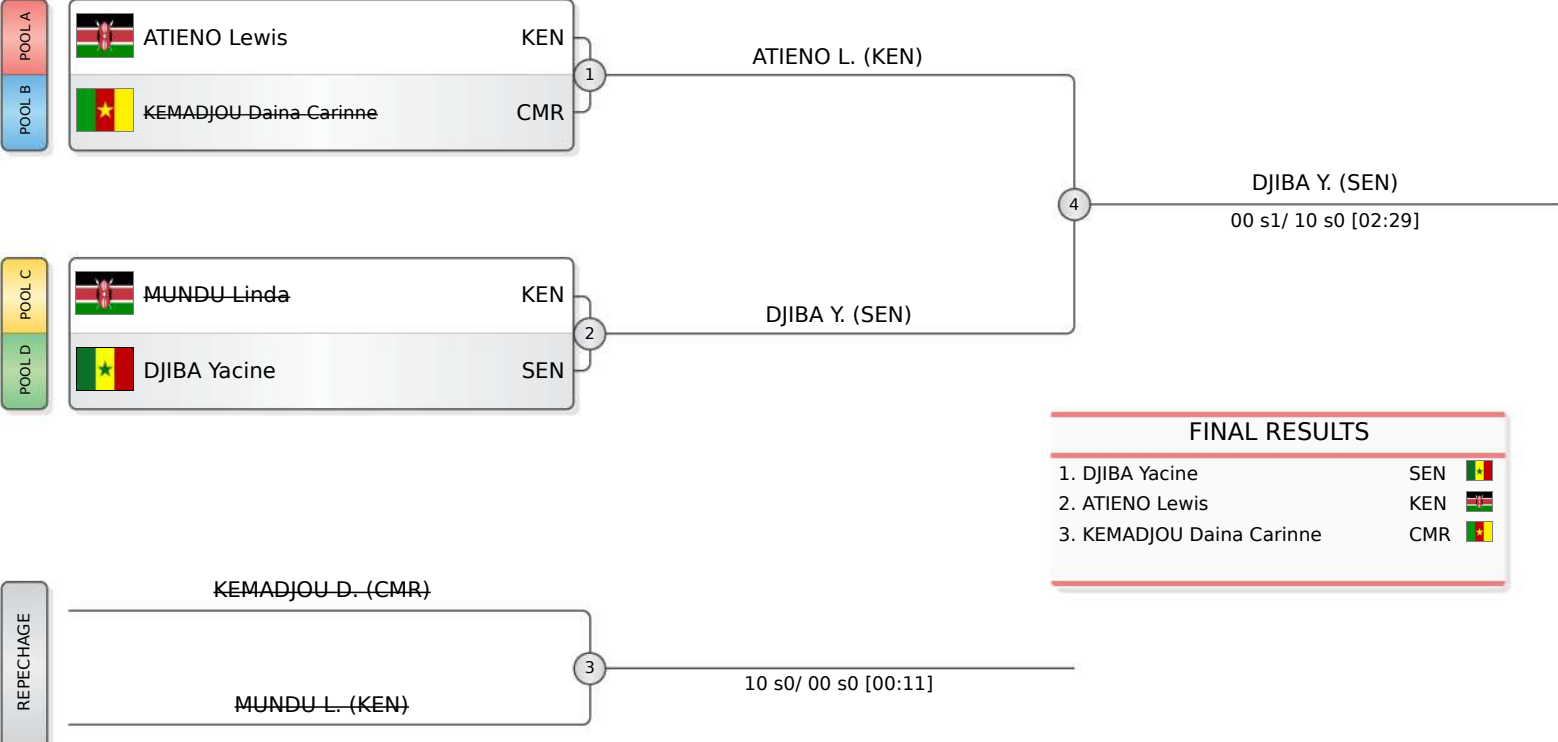



FINAL RESULTS		
1. DJIBA Yacine	SEN	
2. ATIENO Lewis	KEN	
3. KEMADJOU Daina Carinne	CMR	

Num.	Competitor	State	1	3	5	Wins	Points
1.	NSANGOU SECKE Mayra Evelyne Shareefa	Cameroon		0	0	2	0
3.	GUILAVOGUI Monic	Guinea	0		0	0	0
5.	SHARAF Farah	Egypt	0	0		0	0

Num.	Competitor	State	2	4	Wins	Points
2.	SANTOS Naya	Angola		0	0	0
4.	SOLIMAN Safa	Egypt	0		1	0

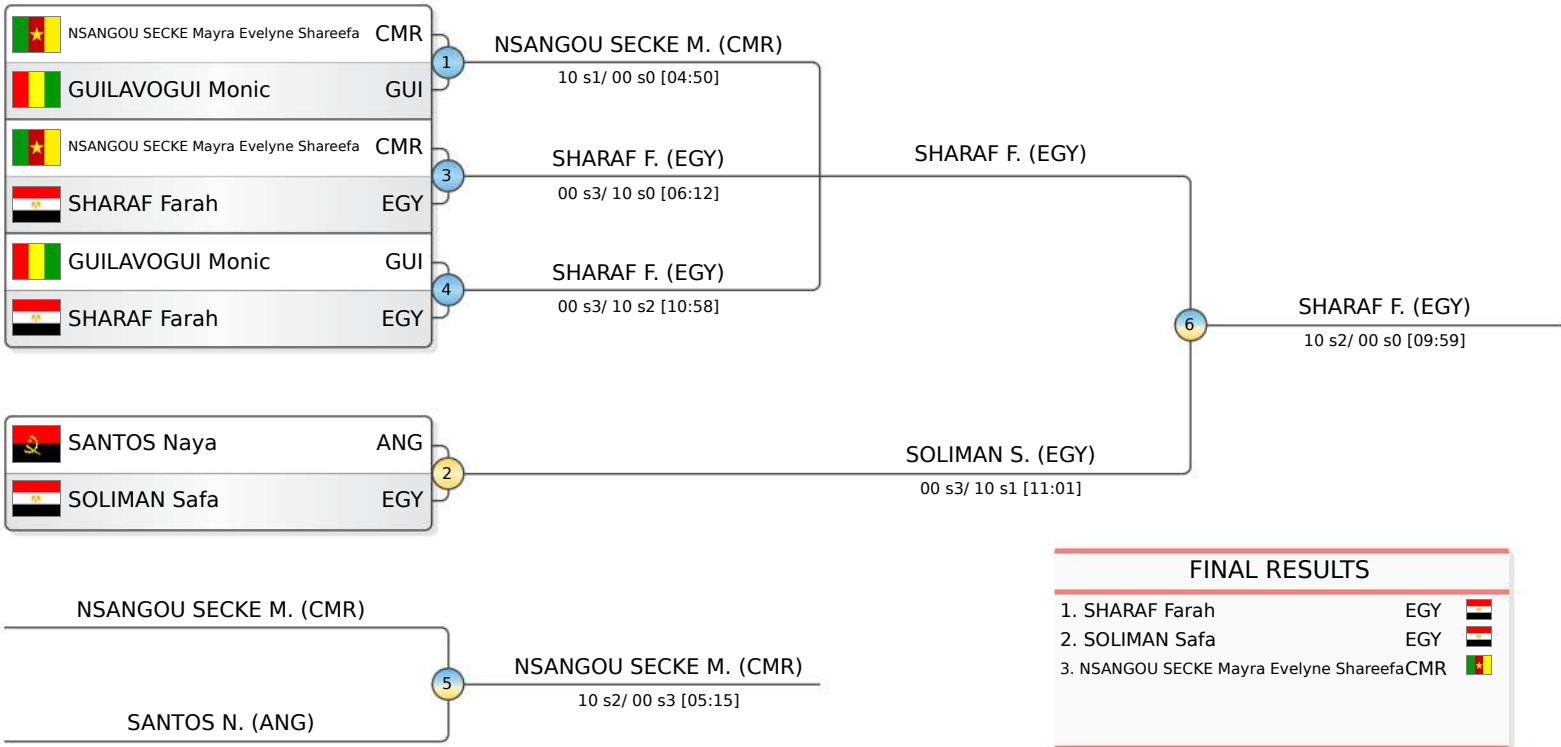

FINAL RESULTS		
1.	SHARAF Farah	EGY
2.	SOLIMAN Safa	EGY
3.	NSANGOU SECKE Mayra Evelyne Shareefa	CMR